

# SYSVRF2 WALL



**GB** Wall-mounted VRF indoor unit  
INSTALLATION MANUAL



## Contents



1. Before Installation .....	3
2. Choosing an Installation Site .....	3
3. Indoor Unit Installation .....	3
4. Refrigerant Piping Installation.....	4
5. Water Discharge Piping and Connecting Piping Installation.....	5
6. Electrical Wiring .....	6
7. On-site Configuration.....	8
8. Test Run .....	9
9. Part Names.....	11
10. Air Conditioner Operations and Performance.....	11
11. Adjusting Air Flow Direction.....	11
12. Maintenance .....	12
13. Symptoms That Are Not Faults.....	13
14. Troubleshooting .....	13

## Installation Manual

### Safety Precautions

Read carefully before you install the air conditioner to make sure that the installation is correct.

There are two types of precautions as described below:

 **Warning:** Failure to comply may lead to death or serious injury.  
 **Caution:** Failure to comply may lead to injury or damage of the unit. Depending on the situation, this may also lead to serious injury. Once the installation is completed, and the unit has been tested and verified to be operating normally, please explain to the customer how to use and maintain the unit according to this manual. In addition, make sure that the manual is kept properly for future reference.

### Warning

- Installation, maintenance and cleaning the filter work must be carried out by professional installers. Refrain from doing it yourself. Improper installation may cause water leakage, electric shock, or fire.
- Install the air conditioner according to the steps described in this manual. Improper installation may cause water leakage, electric shock, or fire.
- For installation in smaller rooms, you must adopt the relevant measures to prevent the refrigerant concentration from exceeding the limit. Please consult the sales agent on the relevant measures required. A high concentration of refrigerant in an airtight space can cause oxygen insufficiency (anoxia).
- Make sure the required parts and accessories are installed. Using unspecified parts may cause the air conditioner to malfunction or drop, as well as water leakage, electric shock, and fire.
- Mount the air conditioner in a place that is sturdy enough to bear its weight. If the base is not secured properly, the air conditioner may drop leading to damages and injuries.
- Take in full consideration to the effects of strong winds, typhoons and earthquakes, and reinforce the installation. Improper installation may cause the air conditioner to drop leading to accidents.
- Make sure a standalone circuit is used for the power supply. All electrical parts must comply with the local laws and regulations, and what is stated in this installation manual. The installation works must be carried out by a professional and qualified electrician. Insufficient capacity or improper electrical works can lead to electric shock or fire.
- Use only electrical cables that fulfil the specifications. All wiring on site must be carried out in accordance with the connection diagram attached to the product. Make sure that there are no external forces acting on the terminals and wires. Improper wiring and installation may cause a fire.







- Make sure the power cord, communication and controller wiring are straight and level when you are working on the connections, and the cover on the electric box is tight. If the electric box is not closed properly, it may lead to electric shock, fire or overheating of electrical components.
- If the refrigerant leaks during installation, open the doors and windows immediately to ventilate the area. Refrigerant can produce toxic gases when in contact with fire.
- Switch off the power supply before touching any electrical component.
- Do not touch the switch with wet hands. This is to prevent electrical shocks.
- Do not come in direct contact with the refrigerant leaking from the connections of refrigerant piping. Otherwise, it may lead to frostbite. The air conditioner must be grounded. Do not connect the earth line (ground) to gas piping, water piping, lightning rods or telephone earth lines. Improper grounding can lead to electric shock or fire, and may cause mechanical failure due to current surges from lightning and so on.
- The earth leakage circuit breaker must be installed. There is a risk of electric shock or fire if the earth leakage circuit breaker is not installed.

### Caution



- Install the water discharge piping according to the steps described in this manual, and make sure that the water discharge is smooth, and the piping is properly insulated to prevent condensation. Improper installation of the water discharge piping may lead to water leakage, and damage the indoor furniture.
- When mounting the indoor and outdoor units, make sure the power cord is installed at a distance of at least 1 m away from any TV or radio so as to prevent noise or interference with the images.
- The refrigerant required for the installation is R410A. Make sure the refrigerant is correct before installation. Incorrect refrigerant may cause the unit to malfunction.
- Do not install the air conditioner in the following places:
  - 1) Where there is oil or gas, such as the kitchen. Otherwise, the plastic parts may age, fall off or water may leak.
  - 2) Where there are corrosive gases (such as sulphur dioxide). Corrosion in the copper pipes or welded parts may cause the refrigerant to leak.
  - 3) Where there are machines emitting electromagnetic waves. Electromagnetic waves may interfere with the control system, causing the unit to malfunction.
  - 4) Where there is a high salt content in the air. When exposed to air with a high salt content, the mechanical parts will experience accelerated ageing which will severely compromise the service life of the unit.
  - 5) Where there are major voltage fluctuations. Operating the unit using a power supply system that has large voltage fluctuations will reduce the service life of the electronic components, and cause the unit's controller system to malfunction.
  - 6) Where there is a risk of leakage of flammable gases. Examples are sites that contain carbon fibres or combustible dust in the air, or where there are volatile combustibles (such as diluent or petrol). The above gases may cause explosion and fire.
  - 7) Do not touch the fins of the heat exchanger as this may lead to injury.
  - 8) Some products use the PP packing belt. Do not pull or tug on the PP packing belt when you transport the product. It will be dangerous if the packing belt breaks.
  - 9) Note the recycling requirements for nails, wood, carton and other packaging materials. Do not discard these materials directly as these may lead to bodily harm.
  - 10) Tear up the packaging bag for recycling to prevent children from playing with it, and leading to suffocation.

## Accessories

Verify that the air conditioner includes the following accessories. Please keep the additional accessories properly.

Name	Appearance	Qty	Function
1. Screws, ST3.9x25		8	Set installation board
2. Plastic expansion tubes		8	_____
3. Winding belt		1	_____
4. Water discharge pipe		1	_____
5. Wall conduit cover		1	_____
6. Manual		1	This manual
7. Brass nuts		1	Pipe connections

### Accessories to purchase locally

Code	Name	Appearance	Dimensions	Qty	Note
1	Copper pipe		Choose and purchase copper pipes that correspond to the length and size calculated for the selected model in the installation manual of the outdoor unit and your actual project requirements.	To purchase based on actual project requirements.	Use to connect indoor refrigerant piping.
2	PVC pipe for water discharge		Outer diameter: 37-39 mm, inner diameter: 32 mm	To purchase based on actual project requirements.	Use to discharge condensed water from the indoor unit.
3	Insulation casing for piping		The inner diameter is based on the diameter of the copper and PVC pipes. The thickness of the pipe casing is 10 mm or more. Increase the thickness of the casing (20 mm or thicker) when the temperature exceeds 30°C or the humidity exceeds RH80%.	To purchase based on actual project requirements.	Protect piping from condensation.

## 1. Before Installation

Make sure you check the packaging during transportation. Claim compensation for any damage from the carrier immediately.

Take note of the following when transporting the equipment:

- 1  Fragile. Handle with care.
- 2 Determine the route to move the unit to the installation site.
- 3 Transport the equipment on the base of the original package as much as possible.
- 4 When lifting the equipment, use a protective device to protect the equipment, prevent damage, and always take note of where the centre of gravity is.

## 2. Choosing an Installation Site

Installation positions of the indoor unit must meet the following requirements:

- Avoid installation in narrow places with stringent noise requirements.
- Wall must be vertical, and the wall structure must be strong enough to bear the weight of the indoor unit.
- Inlets and outlets of the pipeline are not blocked.
- Air flow can reach the entire room.
- Convenient to dismantle the connecting piping and water discharge piping.
- No direct radiation from the heater.
- Do not install at a place with high salt content in the air.

## 3. Indoor Unit Installation

### 3.1 Drill and Mount the Rack for the Indoor Unit

Rack dimensions and direction (unit: mm)

#### 2.2\2.8 kW

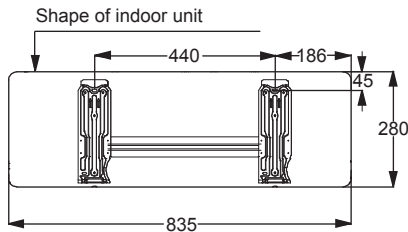

Figure 3.1

#### 3.6\4.5\5.6 kW

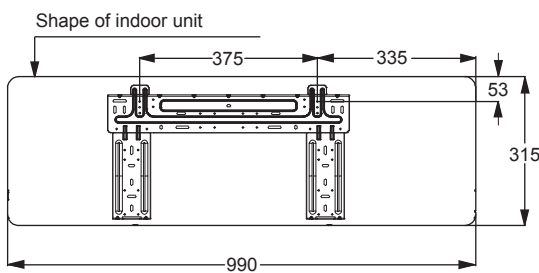

Figure 3.2

#### 7.1\8.0\9.0 kW

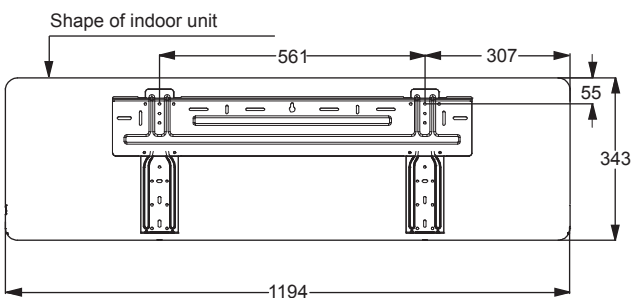

Figure 3.3

### 3.1.1 Mounting the rack for the indoor unit

Select the installation location, and remove the installation panel from the back of the indoor unit, and place it on the installation position you have selected earlier. At this time, make sure the unit is level, and maintain the dimensions of the bottom, top, left and right sides of the unit. Determine the positions of the wall holes to secure the panel.

Correct installation method

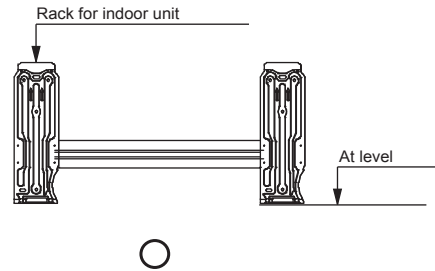

Figure 3.4

Wrong installation method

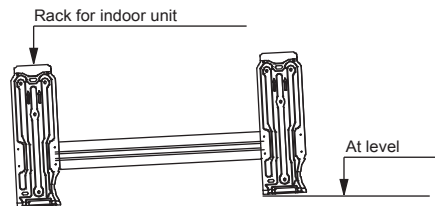

Figure 3.5

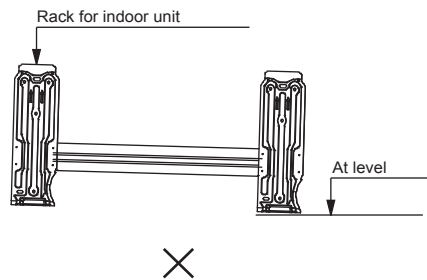

Figure 3.6

### 3.2 Installation on Wood-based Structure

- 1) Before installation, make sure that the wooded walls are strong enough.
- 2) Determine the upper and lower positions of the installation panel based on the distance between the indoor unit and the ceiling.
- 3) With reference to the screw holes of the installation panel as the centre, adjust the distance on the left and right sides.
- 4) Fix the installation panel on the wall using self tapping screws.

### 3.3 Installation on Concrete Structure

- 1) With reference to the installation panel, drill holes in the wall to embed the plastic expansion pipes.
- 2) Fix the installation panel on the wall using self tapping screws.

### 3.4. Indoor Unit Installation

- 1) Pass the properly bundled pipeline and connection lines through the wall hole, making sure that the pipe socket is not damaged, and the connecting pipes of the unit are sand-free and dust-free.
- 2) Hang the upper jaw at the back of the indoor unit on the upper hooker of the installation panel. Shift the indoor unit left and right to check that the hanging is secure and firm.
- 3) Push the lower part of the indoor unit against the wall, and shift the unit body up and down and left and right to check that the connection is secure.
- 4) Place a block of shock absorbing material in between the indoor unit and wall to support the indoor unit. Remove the shock absorbing material when the piping installation work is completed. Until the indoor unit can be connected properly, make sure that the indoor unit is buckled into the slots. Use your hands to shake the unit to check that it does not move up, down, left or right. Use a spirit level to verify that the indoor unit is level.

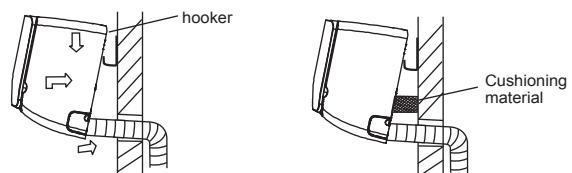

Figure 3.7

## 4. Refrigerant Piping Installation

### 4.1 Length and Level Difference Requirements for the Piping Connections to the Indoor and Outdoor Units

The length and level difference requirements for the refrigerant piping are different for different indoor and outdoor units. Refer to the installation manual of the outdoor unit.

### 4.2 Piping Material and Size

1. Piping material: Copper pipes for air handling.
2. Piping size: Choose and purchase copper pipes that correspond to the length and size calculated for the selected model in the installation manual of the outdoor unit and your actual project requirements.

### 4.3 Piping Layout

1. Seal the two ends of the piping properly before you connect the indoor and outdoor piping. Once unsealed, connect the piping of the indoor and outdoor units as quickly as possible to prevent dust or other debris from entering the piping system via the unsealed ends, as this may cause the system to malfunction.
2. If the piping needs to go through walls, drill the opening in the wall, and place accessories like casings and covers for the opening properly.
3. Place the refrigerant connecting piping and the communication wiring for the indoor and outdoor units together, and bundle them tightly to make sure air does not enter and condensate to form water that may leak from the system.
4. Insert the bundled piping and wiring from outside the room through the wall opening into the room. Be careful when you lay out the piping. Do not damage the piping.

### 4.4 Piping Installation

- Refer to the installation manual attached with the outdoor unit on installation of the refrigerant piping for the outdoor unit.
- All gas and liquid piping must be properly insulated; otherwise, this may cause water to leak. Use heat insulation materials that can withstand high temperatures above 120°C to insulate the gas pipes. In addition, the insulation of the refrigerant piping should be reinforced (20 mm or thicker) in situations where there is high temperature and/or high humidity (when part of refrigerant piping part is higher than 30°C or when the humidity exceeds RH80%). Otherwise, the surface of the heat insulation material may be exposed.
- Before the works are carried out, verify that the refrigerant is R410A. If the wrong refrigerant is used, the unit may malfunction.
- Other than the specified refrigerant, do not let air or other gases enter the refrigeration circuit.
- If the refrigerant leaks during installation, make sure you fully ventilate the room.
- Use two wrenches when you install or dismantle the piping, a common wrench and a torque wrench. See Figure 4.1.

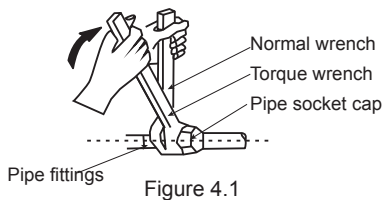

- Slot the refrigerant piping into the brass nut (accessory 8), and expand the pipe socket. Refer to the following table for the size of the pipe socket and the appropriate tightening torque.

Outer diameter of connecting piping (mm)	Tightening torque (N.m)
φ6.4	14.2~17.2
φ9.5	32.7~39.9
φ12.7	49.5~60.3
φ15.9	61.8~75.4
φ19.1	97.2~118.6

#### ⚠ Caution

- Apply the appropriate tightening torque according to the installation conditions. Excessive torque will damage the socket cap, and the cap will not be tight if you apply insufficient torque, leading to leakages.

Do not let air, dust, and other particles invade the piping system during the installation of the connecting pipes.

Install the connecting pipes only when the indoor and outdoor units are secured.

Make sure to keep the connecting pipes dry during installation so that no water will enter the piping system.

- Before the socket cap is installed on the pipe socket, apply some refrigerant oil on the socket (both inside and outside), then rotate it three or four times before you tighten the cap. See Figure 4.2.

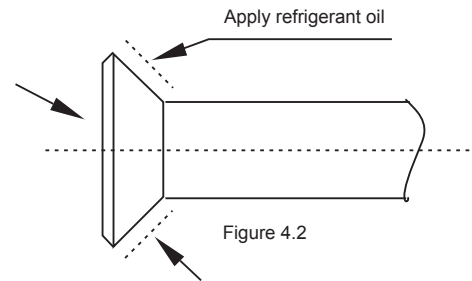

#### ⚠ Precautions to take when welding the refrigerant pipes

- Before you weld the refrigerant pipes, fill the pipes with nitrogen first to discharge the air in the pipes. If no nitrogen is filled during welding, a large amount of oxide film will form inside the piping which may cause the air conditioning system to malfunction.
- Welding can be carried out on the refrigerant pipes when the nitrogen gas has been replaced or refilled.
- When the pipe is filled with nitrogen during welding, the nitrogen must be reduced to 0.02 MPa using the pressure release valve. See Figure 4.3.

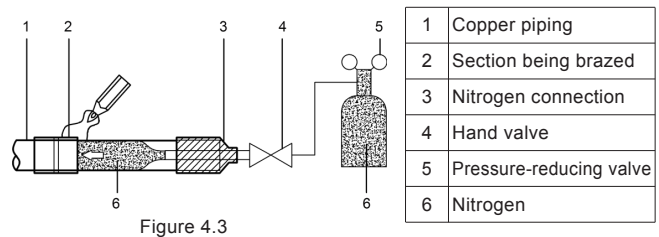

### 4.5 Air Tightness Test

Carry out the air tightness test on the system according to the instructions in the installation manual of the outdoor unit.

#### ⚠ Caution

- The Air Tightness Test helps to ensure that the air and liquid cut-off valves of the outdoor unit are all closed (maintain the factory defaults).

#### 4.6 Heat Insulation Treatment for Gas-Liquid Piping Connections for the Indoor Unit

- ♦ The heat insulation treatment is carried out on the piping at the gas and liquid sides of the indoor unit respectively.
  - a. The piping on the gas side must use heat insulation material that can withstand temperatures of 120°C and more.
  - b. For the piping connections of the indoor unit, use the insulation casing for copper pipes to carry out the insulation treatment, and close all gaps.

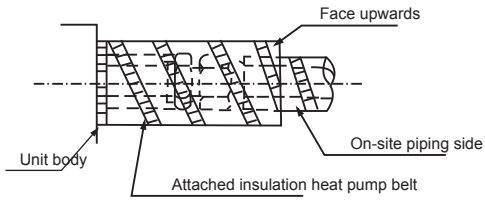

Figure 4.4

#### 4.7 Vacuum

Create a vacuum in the system according to the instructions in the installation manual of the outdoor unit.

##### ⚠ Caution

- For the vacuum, make sure that the air and liquid cut-off valves of the outdoor unit are all closed (maintain the factory status).

#### 4.8 Refrigerant

Charge the system with refrigerant according to the instructions in the installation manual of the outdoor unit.

### 5. Water Discharge Piping and Connecting Piping Installation

#### 5.1 Installation of the Water Discharge Piping for Indoor Unit

- Tilt the water discharge pipe downwards. Make sure the following situations do not arise when the water discharge pipes are being installed:

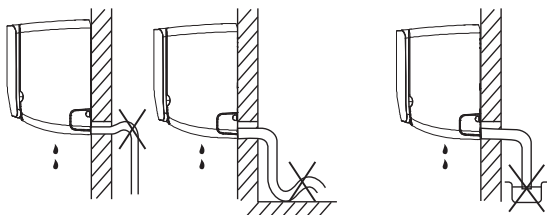

Figure 5.1

- When connecting to a long water discharge pipe, the indoor unit portion must be covered with insulation casing. Make sure the long pipe does not become loose.

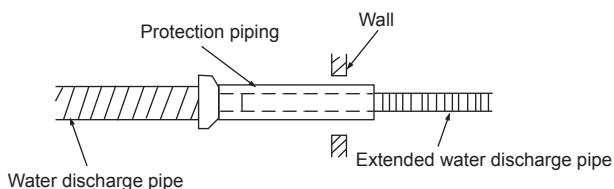

Figure 5.2

#### 5.2 Installation of the Connecting Piping for Indoor Unit

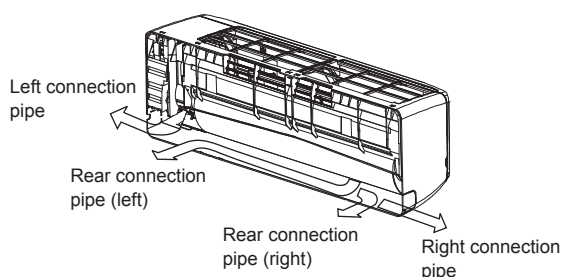

Figure 5.3

- Use the following operations to join the left connection pipe and the rear connection pipe (left). Bend the connecting pipe, and place it at a maximum of 43 mm from the wall.

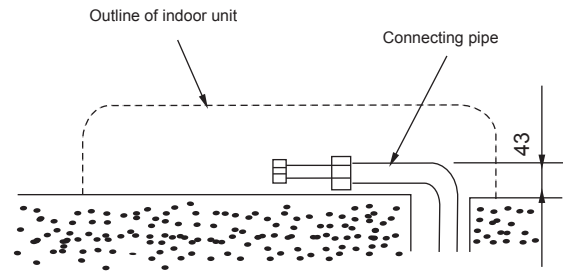

Figure 5.4

- Secure the tail-ends of the connecting pipes (refer to the portion on fixing and securing the connections in connecting the refrigeration piping).

##### ⚠ Caution

- First install the indoor unit. Then install the outdoor unit. Be careful of bends and adjust the pipeline accordingly.
- Do not expose the pipeline at the back of the indoor unit.
- Make sure the water discharge pipes are not loose and moving.
- Make sure all the connections in the piping system are properly sealed to prevent water leakages.

#### 5.3 Binding the Pipes:

- 1) Bind in the following sequence: power cord and signal line on top, connecting pipe in the middle, and water piping below.
- 2) Confirm where the water outlet is before you connect the water discharge pipe.
- 3) Do not pull the snake tube hard during the binding process.
- 4) Cover the insulation materials if the pipes are pulled out horizontally.
- 5) Avoid the connection joints during binding to in preparation of leakage checks.
- 6) When the water discharge pipe is not long enough, and there is a need to extend the water discharge pipe, make sure that protecting casing is used to wrap the indoor portion for the extended pipe. Make sure the water piping is not coiled anywhere.

#### 5.4 Water Discharge Test

Once the water discharge piping is installed, inject a small amount of water into the water pan to check if the drainage is smooth.

##### ⚠ Caution

- The condensed water in the rear of the indoor unit is gathered in the water pan and discharged from the piping. Do not place anything in the water pan.

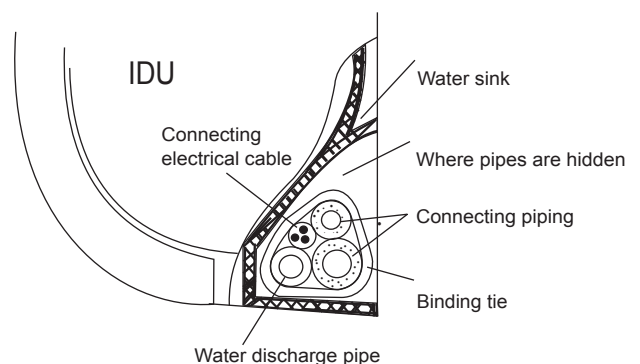

Figure 5.5

## 5.5 Material and Size of the Piping

Table 5.1

Pipe Material		Copper Pipe for Air Conditioner	
Model(kW)		≤4.5	≥5.6
Size(mm)	(Gas side)	Φ12.7	Φ15.9
	(Liquid side)	Φ6.4	Φ9.5

### ⚠ Note

- Refer to the air conditioner pipeline connection method for the installation.

## 6. Electrical Wiring

### ⚠ Warning

- All the supplied parts, materials and electrical works must comply with local regulations.
- Use only copper wires.
- Use a dedicated power supply for the air-conditioners. The power voltage must be in line with the rated voltage.
- The electrical wiring works must be carried out by a professional technician, and must comply with the labels stated in the circuit diagram.
- Before the electrical connection works are carried out, turn off the power supply to prevent injuries caused by electric shock.
- The external power supply circuit of the air conditioner must include an earth line, and the earth line of the power cord connecting to the indoor unit must be securely connected to the earth line of the external power supply.
- Leakage protective devices must be configured according to the local technical standards and requirements for electrical and electronic devices.
- The fixed wiring connected must be equipped with an all-pole disconnection device with a minimum 3 mm contact separation.
- The distance between the power cord and signalling line must be at least 300 mm to prevent the occurrences of electrical interference, malfunction or damage to electrical components. At the same time, these line must not come in contact with the piping and valves.
- Choose electrical wiring that conforms to the corresponding electrical requirements.
- Connect to the power supply only after all the wiring and connection works have been completed, and carefully checked to be correct.

### 6.1 Power Cord Connection

- Use a dedicated power supply for the indoor unit that is different from the power supply for the outdoor unit.
- Use the same power supply, circuit breaker and leakage protective device for the indoor units connected to the same outdoor unit.

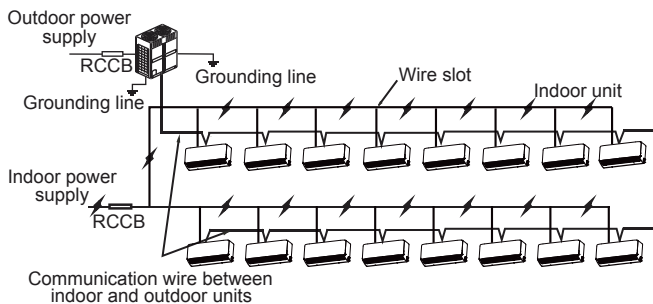

Figure 6.1

Figure 6.2 shows the power supply terminal of the indoor unit.

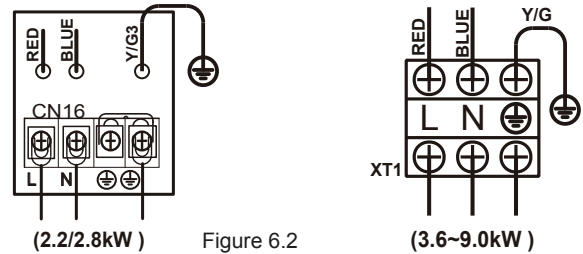

Figure 6.2

When connecting to the power supply terminal, use the circular wiring terminal with the insulation casing (see Figure 6.3).

Use power cord that conforms to the specifications and connect the power cord firmly. To prevent the cord from being pulled out by external force, make sure it is fixed securely.

If circular wiring terminal with the insulation casing cannot be used, please make sure that:

- Do not connect two power cords with different diameters to the same power supply terminal (may cause overheating of wires due to loose wiring) (See Figure 6.4).

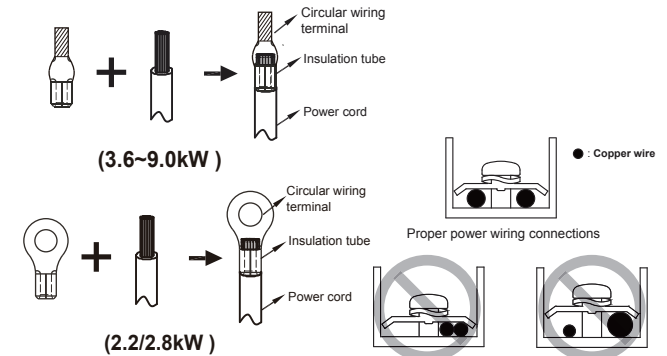

Figure 6.3

Figure 6.4

### 6.2 Electrical Wiring Specifications

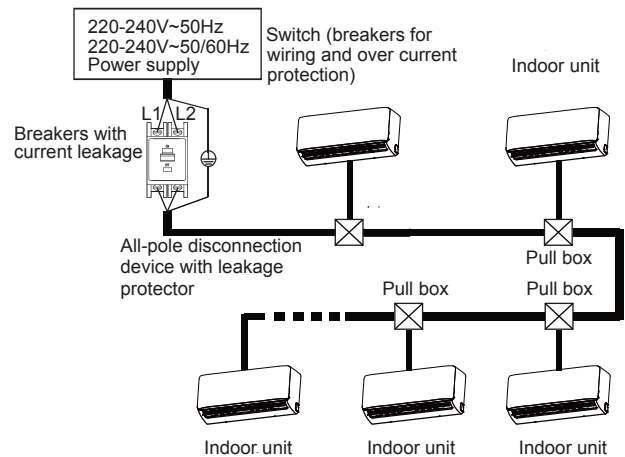

Figure 6.5

Refer to Tables 6.1 and 6.2 for the specifications of the power cord and communication wire. A wiring capacity that is too small will cause the electrical wiring to become too hot, and lead to accidents when the unit burns and becomes damaged.

Table 6.1

Model		2.2~9.0kW
Power supply	Phase	1-phase
	Volt and frequency	220-240V~50Hz 220-240V~50/60Hz
Communication wire between indoor and outdoor units		Shielded 3*AWG16-AWG18
Communication wire between indoor unit and wired controller *		Shielded AWG16-AWG20
Field fuses		15A

\* Please refer to the corresponding wired controller manual for the wired controller wiring.

**Table 6.2 Indoor units electrical characteristics**

Capacity	Power supply				IFM	
	Hz	Volts	MCA	MFA	kW	FLA
2.2kW	50/60	220-240	0.32	15	0.02	0.25
2.8kW	50/60	220-240	0.32	15	0.02	0.25
3.6kW	50/60	220-240	0.45	15	0.058	0.36
4.5kW	50/60	220-240	0.47	15	0.058	0.37
5.6kW	50/60	220-240 <td 0.58	15	0.058	0.46	
7.1kW	50/60	220-240	0.90	15	0.06	0.72
8.0kW	50/60	220-240	0.90	15	0.06	0.72
9.0kW	50/60	220-240	1.1	15	0.06	0.88

Abbreviations:

MCA: Minimum Circuit Amps

MFA: Maximum Fuse Amps

IFM: Indoor Fan Motor

kW: Rated motor output

FLA: Full Load Amps

**Warning**

Refer to local laws and regulations when deciding on the dimensions for the power cords and wiring. Get a professional to select and install the wiring.

**6.3 Communication Wiring**

- Use only shielded wires for the communication wiring. Any other type of wires may produce a signal interference that will cause the units to malfunction.
- Do not carry out electrical works like welding with the power on.
- All shielded wiring in the network are interconnected, and will eventually connect to earth at the same point "⊕".
- Do not bind the refrigerant piping, power cords and communication wiring together. When the power cord and communication wiring are parallel, the distance between the two lines must be 300 mm or more in order to prevent signal source interference.
- Communication wiring must not form a closed loop.

**6.3.1 Communication wiring between the indoor and outdoor units**

- The indoor and outdoor units communicate via the RS485 serial port.
- The communication wiring between the indoor and outdoor units should be connected one unit after another in a daisy chain from the outdoor unit to the final indoor unit. And the shielded layer must be properly grounded, and a build-out resistor must be added to the last indoor unit to enhance the stability of the communication system (see Figure 6.6).
- Incorrect wiring such as a star connection or a closed ring will cause instability of the communication system and system control anomalies.
- Use a three core shielded wire (greater than or equal to 0.75 mm<sup>2</sup>) for the communication wiring between the indoor and outdoor units. Make sure the wiring is connected correctly. The connecting lead for this communication wire must come from the master outdoor unit.

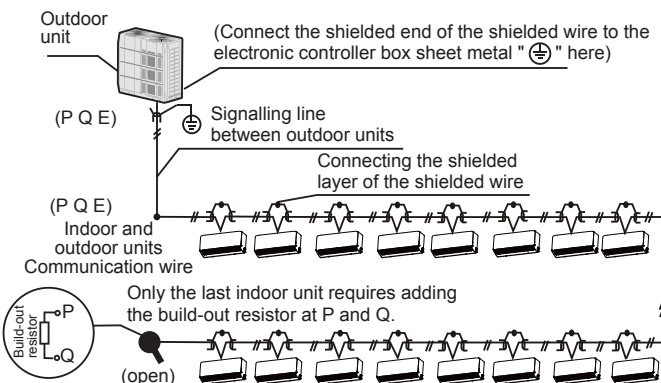

Figure 6.6

**6.3.2 Communication wiring between the indoor unit and wired controller**

The wired controller and the indoor unit can be connected in different manners, depending on the forms of communication.

1) For a bidirectional communication mode:

- Use 1 wired controller to control 1 indoor unit or 2 wired controllers (one master and one slave controller) to control 1 indoor unit (see Figure 6.7);
- Use 1 wired controller to control multiple indoor units or 2 wired controllers (one master and one slave controller) to control multiple indoor units (see Figure 6.8);

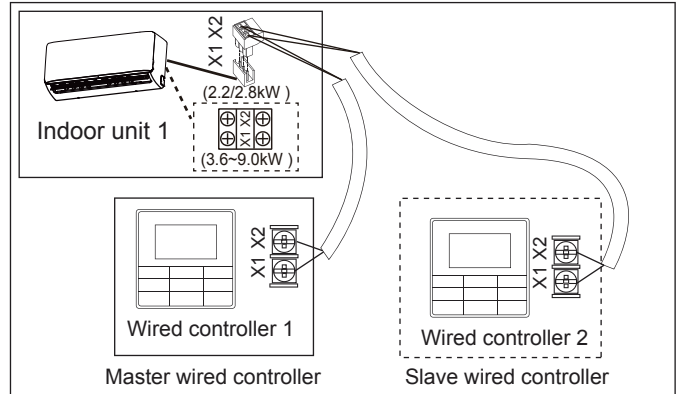

Figure 6.7

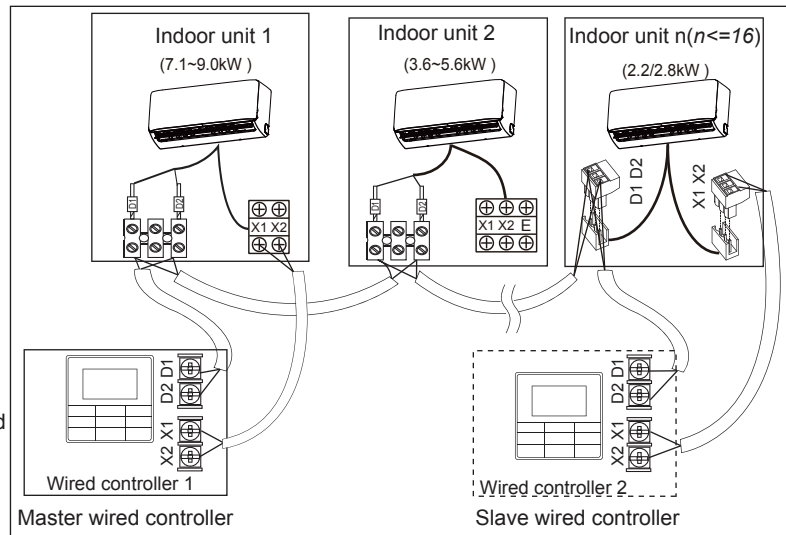

Figure 6.8

For a unidirectional communication mode:

Use 1 wired controller to control 1 indoor unit (see Figure 6.9).

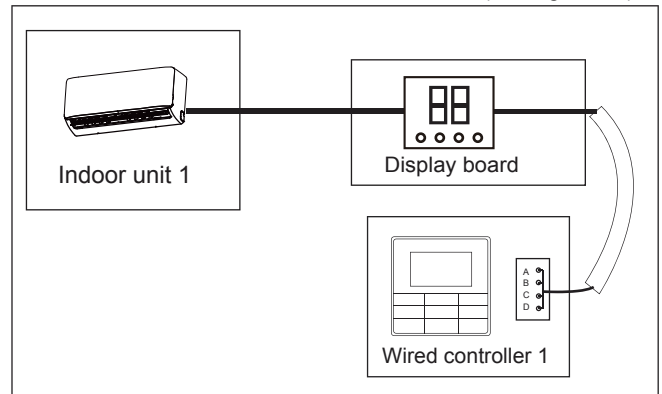

Figure 6.9



- For the specific connection method, refer to the instructions in the corresponding wired controller manual to carry out the wiring and connections.
- The X1, X2, D1, D2 ports on the sides of the main control board and the unidirectional communication port (display board side) are for different types of wired controllers (see Figure 6.10).
- Use the connecting wires (accessory 7) to connect the D1, D2 ports.

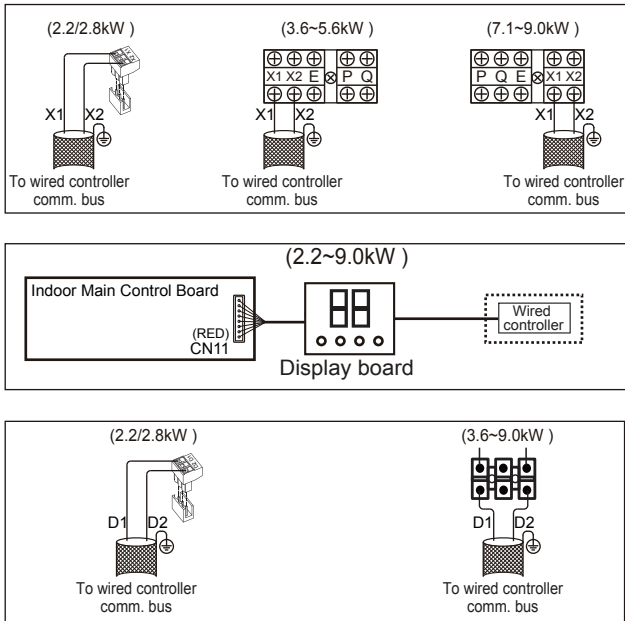

Figure 6.10

### 6.5 Handling the Electrical Wiring Connection Points

- Once the wiring and connections are done, use tie straps to secure the wiring properly so that the connection joint cannot be pulled apart by external force. The connection wiring must be straight out so that the cover of the electrical box is level and can be closed tightly.
- Use professional insulation and sealing materials to seal and protect the perforated wires. Poor sealing may lead to condensation, and entry of small animals and insects that may cause short circuits in parts of the electrical system, causing the system to fail.

## 7. On-site Configuration

### 7.1 Capacity Settings

Set up the PCB board DIP switch on the indoor electric control box to cater to different uses. Once the settings are done, make sure you cut off the main power switch again, and then switch the power on. If the power is not cut off and switched on again, the settings will not be executed.

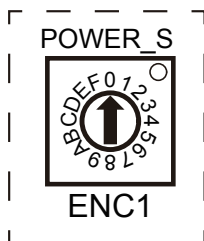

DIP Switch Code	Capacity
Code	Capacity (hp)
0	2200W(0.8HP)
1	2800W(1.0HP)
2	3600W(1.2HP)
3	4500W(1.5HP)
4	5600W(2.0HP)
5	7100W(2.5HP)
6	8000W(3.0HP)
7	9000W(3.2HP)

### ⚠ Caution

- The capacity DIP switches have been configured before delivery. Only a professional maintenance personnel should change these settings.

### 7.2 Address Settings

When this indoor unit is connected to the outdoor unit, the outdoor unit will automatically allocate the address to the indoor unit. Alternatively, you may use the controller to manually set the address.

- The addresses of any two indoor units in the same system cannot be the same.
- The network address and the indoor unit address are the same, and does not have to be configured separately.
- Once the address settings are completed, mark the address of each indoor unit to facilitate after-sales maintenance.
- The centralized control of the indoor unit is completed on the outdoor unit. For details, refer to the manual on the outdoor unit.

### ⚠ Caution

- Once the centralized control function for the indoor unit has been completed on the outdoor unit, the DIP switch on main control panel of the outdoor unit must be set to auto addressing; otherwise, the indoor unit in the system are not controlled by the centralized controller.
- The system can connect up to 64 indoor units (address 0~63) at the same time. Each indoor unit can only have one address DIP switch in the system. The addresses of any two indoor units in the same system cannot be the same. Units that have the same address may malfunction.

### 7.3 DIP Switch Settings on Main Board





SW1_1	
SW1 [ 0 ]	Cooling mode temperature compensation is 0°C
SW1 [ 1 ]	Cooling mode temperature compensation is 2°C
SW1_2	
SW1 [ 0 ]	EEV at position 96 (steps) in standby in heating mode (default)
SW1 [ 1 ]	EEV at position 72 (steps) in standby in heating mode





SW2	
SW2 [ 0 ]	 Factory settings





SW3_1	
SW3 [ 0 ]	 Reserved

SW3 [ 1 ]	 Clear indoor unit address
--------------	---



SW3_2	
SW3 [ 0 ]	 Reserved



SW4	
SW4 [00]	 In heating mode when the set temperature has been reached, the fan operates in a 4 minutes off / 1 minute on repeating cycle
SW4 [01]	 In heating mode when the set temperature has been reached, the fan operates in an 8 minutes off / 1 minute on repeating cycle
SW4 [10]	 In heating mode when the set temperature has been reached, the fan operates in a 12 minutes off / 1 minute on repeating cycle
SW4 [11]	 In heating mode when the set temperature has been reached, the fan operates in a 16 minutes off / 1 minute on repeating cycle

SW5	
SW5 [00]	 In heating mode fan does not run when indoor heat exchanger mid-point temperature is 15°C or below
SW5 [01]	 In heating mode fan does not run when indoor heat exchanger mid-point temperature is 20°C or below
SW5 [10]	 In heating mode fan does not run when indoor heat exchanger mid-point temperature is 24°C or below
SW5 [11]	 In heating mode fan does not run when indoor heat exchanger mid-point temperature is 26°C or below

SW6	
SW6 [00]	 Heating mode temperature compensation is 6°C
SW6 [01]	 Heating mode temperature compensation is 2°C
SW6 [10]	 Heating mode temperature compensation is 4°C
SW6 [11]	 Heating mode temperature compensation is 0°C (use follow me function)

SW7: reserved

J1	
J1 [ 0 ]	 Auto restart function enabled
J1 [ 1 ]	 Auto restart function disabled

0/1 definition of each dial code switch:	
 means 0	 means 1

**⚠ Caution**

- All DIP switches (including the capacity DIP switch) have been configured before delivery. Only a professional maintenance personnel should change these settings.
- Improper DIP switch settings may cause condensation, noise, or unexpected system malfunction.

#### 7.4 Error Codes and Definitions

Error code	Content
E0	Mode conflict
E1	Communication error between indoor and outdoor units
E2	Indoor ambient temperature sensor (T1) error
E3	Indoor heat exchanger mid-point temperature sensor(T2) error
E4	Indoor heat exchanger outlet temperature sensor (T2B) error
E6	Fan error
E7	EEPROM error
Eb	Indoor EEV coil error
Ed	Outdoor unit error
EE	Water level error
FE	Indoor unit has not been assigned an address

### 8. Test Run

#### 8.1 Things to Note Before Test Run

- Indoor and outdoor units are properly installed;
- Piping and wiring are correct;
- No leakage from the refrigerant piping system;
- Water discharge is smooth;
- Insulation is complete;
- Grounding line has been properly connected;
- Piping length, and amount of refrigerant filled have been recorded;
- The voltage of the power supply is the same as the rated voltage of the air conditioner;
- No obstacles at the air inlet and outlet of the indoor and outdoor units;
- Cut-off valves for the gas and liquid ends of the outdoor unit are opened;

#### 8.2 Test Run

When the wired/remote controller is used to set the cooling operations of the air conditioner, check the following items one by one. If there is a fault, troubleshoot according to the manual.

- Function keys of the wired/remote controller are operating normally;
- Room temperature regulation is normal;
- LED indicator is on;
- Water discharge is normal;
- No vibration and strange sounds during operation;

Note: Once the power is connected, when the unit is turned on or started immediately after the unit is turned off, the air conditioner has a protective function which delays the start of the compressor.

## Operation manual

There are two types of precautions as described below:

 **Warning:** Failure to comply may lead to death or serious injury.

 **Caution:** Failure to comply may lead to injury or damage of the unit. Depending on the situation, this may also lead to serious injury. Once the installation is completed, please keep the manual properly for future reference. When this air conditioner is handed over to other users, make sure that the manual is included with the handover.

### Warning

- Do not use this unit in locations where flammable gas may exist. If flammable gas comes into contact with the unit, a fire may occur, which could result in serious injury or death.
- If this unit exhibits any abnormal behavior (such as emitting smoke) there is a danger of serious injury. Disconnect the power supply and contact your supplier or service engineer immediately.
- The refrigerant in this unit is safe and should not leak if the system is designed and installed properly. However, if a large amount of refrigerant leaks into a room, the oxygen concentration will decrease rapidly, which can cause serious injury or death. The refrigerant used in this unit is heavier than air, so the danger is greater in basements or other underground spaces. In the event of a refrigerant leak, turn off any devices that produce a naked flame and any heating devices, ventilate the room, and contact your supplier or service engineer immediately.
- Toxic fumes may be produced if the refrigerant in this unit comes into contact with naked flames (such as from a heater, gas stove/burners, or electric appliances).
- If this unit is used in the same room as a cooker, stove, hob, or burner, ventilation for sufficient fresh air must be ensured, otherwise the oxygen concentration will fall, which may cause injury.
- Dispose of this unit's packaging carefully, so children cannot play with it. Packaging, especially plastic packaging, can be dangerous, can cause serious injury or death. Screws, staples and other metal packaging components can be sharp and should be disposed of carefully to avoid injury.
- Do not attempt to inspect or repair this unit yourself. This unit should only be serviced and maintained by a professional air conditioning service engineer. Incorrect servicing or maintenance can cause electric shocks, fire or water leaks.
- This unit should only be re-positioned or re-installed by a professional technician. Incorrect installation can lead to electric shocks, fire or water leaks. The installation and grounding of electrical appliances should only be carried out by licensed professionals. Ask your supplier or installation engineer for further information.
- Do not allow this unit or its remote controller to come into contact with water, as this can lead to electric shocks or fire.
- Turn off the unit before cleaning it to avoid electric shocks. Otherwise, an electric shock and injury may result.
- To avoid electric shocks and fires, install an earth leakage detector.
- Do not use paint, varnish, hair spray, other flammable sprays or other liquids that may give off flammable fumes/vapor near this unit, as doing so can cause fires.
- When replacing a fuse, ensure that the new fuse to be installed completely complies with requirements.
- Do not open or remove the unit's panel when the unit is powered on. Touching the unit's internal components while the unit is powered on can lead to electric shocks or injuries caused by moving parts such as the unit's fan.
- Ensure that the power supply is disconnected before any servicing or maintenance is carried out.

- Do not touch the unit or its remote controller with wet hands, as doing so can lead to electric shocks.
- Do not allow children to play near this unit, as doing so risks injury.
- Do not insert your fingers or other objects into the unit's air inlet or air outlet to avoid injury or damage to the equipment.
- Do not spray any liquids onto the unit or allow any liquids to drip onto the unit.
- Do not place vases or other liquid containers on the unit or in places where liquid could drip onto it. Water or other liquids that come into contact with the unit can lead to electric shocks or fires.
- Do not remove the remote controller's front or back covers and do not touch the remote controller's internal components, as doing so can cause injury. If the remote controller stops working, contact your supplier or service engineer.
- Ensure that the unit is properly grounded, otherwise electric shocks or a fire may result. Electrical surges (such as those that can be caused by lightning) can damage electrical equipment. Ensure that suitable surge protectors and circuit breakers are properly installed, otherwise electric shocks or a fire may result.
- Dispose of this unit properly and in accordance with regulations. If electrical appliances are disposed of in landfills or dumps, hazardous substances can leak into the groundwater and thus enter the food chain.
- Do not use the unit until the qualified technician instructs you that it is safe to do so.
- Do not place appliances that produce naked flames in the path of the airflow from the unit. The airflow from the unit may increase the rate of combustion, which may cause a fire and cause serious injury or death. Alternatively, the airflow may cause incomplete combustion which can lead to reduced oxygen concentration in the room, which can cause serious injury or death.

### Caution

- Only use the air conditioner for its intended purpose. This unit should not be used to provide refrigeration or cooling for food, plants, animals, machinery, equipment or art.
- Do not insert your fingers or other objects into the unit's air inlet or air outlet to avoid injury or damage to the equipment.
- The fins on the unit's heat exchanger are sharp and can cause injury if touched. To prevent injury, when the unit is being serviced, gloves should be worn or the heat exchanger should be covered.
- Do not place items which might be damaged by moisture under the unit. When the humidity is greater than 80% or if the drain pipe is blocked or the air filter is dirty, water could drip from the unit and damage objects placed under the unit.
- Ensure that the drain pipe functions properly. If the drain pipe is blocked by dirt or dust, water leaks may occur when the unit is running in cooling mode. If this happens, turn the unit off and contact your supplier or service engineer.
- Do not touch the internal parts of the controller. Do not remove the front panel. Some internal parts may cause injury or be damaged.
- Ensure that children, plants and animals are not directly exposed to the airflow from the unit.
- When fumigating a room with insecticide or other chemicals, cover the unit well and do not run it. Failure to observe this caution could lead to chemicals getting deposited inside the unit and later emitted from the unit when it running, endangering the health of any room occupants.
- Do not dispose of this product as unsorted waste. It must be separately collected and processed. Ensure that all applicable legislation regarding the disposal of refrigerant, oil and other materials is adhered to. Contact your local waste disposal authority for information about disposal procedures.

- To avoid damaging the remote controller, exercise caution when using it and replacing its batteries. Do not place objects on top of it.
- Do not place appliances that have naked flames under or near the unit, as heat from the appliance can damage the unit.
- Do not place the unit's remote controller in direct sunlight. Direct sunlight can damage the remote controller's display.
- Do not use strong chemical cleaners to clean the unit, as doing so can damage the unit's display or other surfaces. If the unit is dirty or dusty, use a slightly damp cloth with very diluted and mild detergent to wipe the unit. Then, dry it with a dry cloth.
- Children shall not play with the appliance.

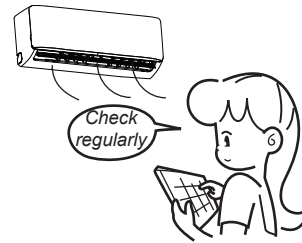

Figure 10.1

- ♦ Avoid too much outdoor air coming into air-conditioned spaces.



Figure 10.2

- ♦ Note that outlet air is cooler or heater than set room temperature. Avoid direct exposure to outlet air as it may be too cool or hot.

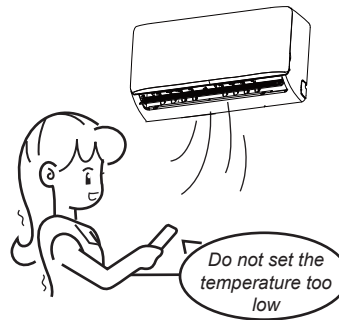

Figure 10.3

- ♦ Maintain a proper air distribution. Air outlet louvers should be used to adjust the direction of outlet airflow, as doing so might ensure more efficient operation.



Figure 10.4

## 9. Part Names

The figure shown above is for reference only and may be slightly different from the actual product.

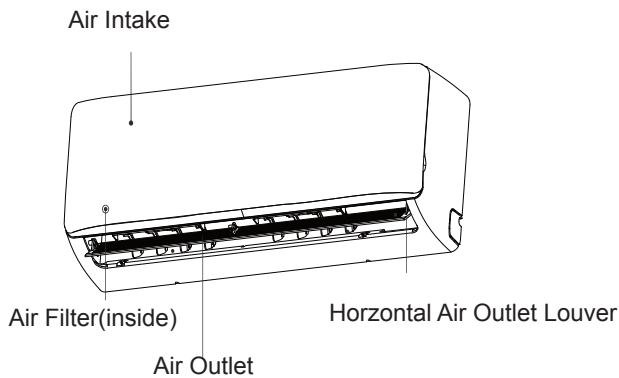

Figure 9.1

## 10. Air Conditioner Operations and Performance

The operating temperature range under which the unit runs stably are given in below table.

Mode	Indoor temperature
Cooling	17-32°C If the indoor humidity is above 80%, condensation may form on the surface of the unit.
Heating	≤27°C

### ⚠ Caution

- The unit performs stably in the temperature range given in above table. If the indoor temperature is outside the unit's normal operating range, it may stop running and display an error code.

To ensure the desired temperature is achieved efficiently, ensure that:

- ♦ All windows and door are closed.
- ♦ The airflow direction is adjusted to work in running mode.  
The air filter is clean.

Please note how you can best save energy and achieve the best cooling/heating effect.

- ♦ Regularly clean air filters inside indoor units.

## 11. Adjusting Air Flow Direction

Since warmer air rises and cooler air falls, the distribution of warmed/cooled air around a room can be improved by positioning the unit's louvers. The louver angle can be adjusted by pressing the [SWING] button on the remote controller.

**⚠ Caution**

- During heating operation, horizontal airflow will aggravate the uneven distribution of room temperature.
- The louver direction: horizontal airflow is recommended during cooling operation. Note the downward airflow will cause condensation on the air outlet and louver surface.

- ◆ Adjust the air direction up and down
  - a. Auto-swing: Press SWING for the louver to swing up and down.
  - b. Manual swing: Adjust the louver to improve the cooling or heating effect.
  - c. When cooling adjust the louver horizontally.

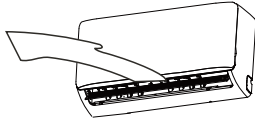

Figure 11.1

- d. When heating adjust the louver downward.

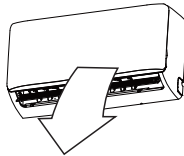

Figure 11.2

## 12. Maintenance

**⚠ Caution**

- Before you clean the air conditioner, ensure it is powered off.
- Check that the wiring is undamaged and connected.
- Use a dry cloth to wipe the indoor unit and remote controller.
- A wet cloth may be used to clean the indoor unit if it is very dirty.
- Never use a damp cloth on the remote controller.
- Do not use a chemically treated duster on the unit or leave this type of material on the unit to avoid damaging the finish.
- Do not use benzene, thinner, polishing powder, or similar solvents for cleaning. These may cause the plastic surface to crack or warp.

◆ **Method for cleaning the air filter**

- a. The air filter can prevent the dust or other particles from entering the unit. If the filter is blocked, the unit will not work well. Clean the filter every two weeks when you use it regularly.
- b. If the air conditioner is positioned in a dusty place, clean the filter often.
- c. Replace the filter if it is too dusty to clean (the replaceable air filter is an optional fitting).

1. Open the unit

Open the unit by placing your fingers under the notches on the sides of the cover and moving the cover outwards. Open the cover fully to allow sufficient room to remove the filter.

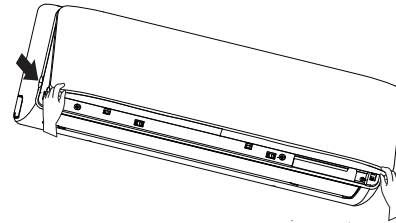

Figure 12.1

2. Dismantle the filter

Gently push the filter upwards to release the notches, then pull the filter out.

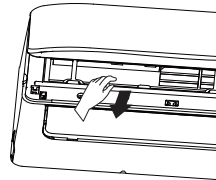

Figure 12.2

3. Clean the air filter

- ◆ Dusts will accumulate on the filter along with the unit operation, and need to be removed from the filter, or the unit would not function effectively.
- ◆ Clean the filter every two weeks when you use the unit regularly.
- ◆ Clean the air filter with a vacuum cleaner or water.
  - a. The air intake side should face up when using a vacuum cleaner. (Refer to Figure 12.3)
  - b. The air intake side should face down when using clean water. (Refer to Figure 12.4)
- ◆ For excessive dusts, use a soft brush and natural detergent to clean it and dry in a cool place.

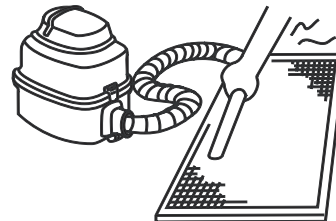

Figure 12.3

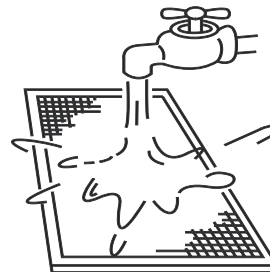



Figure 12.4

 **Caution**

- Do not dry out the air filter under direct sunshine or with fire.
- The air filter should be installed before the unit body installation.

4. Re-install the air filter.
  5. Install and close the air inlet grille by reversing steps 1 and 2.
- ♦ **Maintenance before stopping using the unit for a long time (e.g., at the end of a season)**
    - a. Let the indoor units run in fan only mode for about half a day to dry the interior of the unit.
    - b. Clean the air filter and indoor unit casing.
    - c. Refer to "Cleaning the air filter" for details. Install cleaned air filters back in their original positions.
    - d. Turn off the unit with the ON/OFF button on the remote controller, and then unplug it.

 **Caution**

- When the power switch is connected, some energy will be consumed even if the unit is not running. Disconnect the power to save energy.
- A degree of dirt will accumulate when the unit has been used several times, which will require cleaning.
- Take of the batteries from the remote controller.

- ♦ **Maintenance after a long period of non-use**
  - a. Check for and remove anything that might be blocking the inlet and outlet vents of the indoor units and outdoor units.
  - b. Clean the unit casing and clean the filter. Refer to [Cleaning the filter] and "Cleaning the filter" for instructions. Re-install the filter before running the unit.
  - c. Turn on the power at least 12 hours before you want to use the unit to ensure it works properly. As soon as the power is turned on, the remote control display appears.

### 13. Symptoms That Are Not Faults

The following symptoms may be experienced during the normal operation of the unit and are not considered faults. Note: If you are not sure whether a fault has occurred, contact your supplier or service engineer immediately.

#### Symptom 1: The unit will not run

- ♦ Symptom: When the ON/OFF button on the remote controller is pressed, the unit does not immediately start running.  
Cause: to protect certain system components, system start-up or re-start is intentionally delayed for up to 12 minutes under some operating conditions. If the OPERATION LED on the unit's panel is lighting, the system is working normally and the unit will start after the intentional delay is complete.
- ♦ Heating mode is running when the following panel lights are on: operation and the DEF./FAN LED indicator.  
Cause: the indoor unit activates protective measures because of the low outlet temperature.

#### Symptom 2: The unit emits white mist

- ♦ White mist is generated and emitted when the unit starts to operate in a very humid environment. This phenomenon will stop once the humidity in the room is reduced to normal levels.
- ♦ The unit occasionally emits white mist when it runs in heating mode. This occurs when the system finishes periodic defrosting. Moisture that may accumulate on the unit's heat exchanger coil during defrosting becomes mist and is emitted from the unit.

#### Symptom 4: Dust is emitted from the unit

- ♦ This can occur when the unit first runs after a long idle period.

#### Symptom 5: The unit gives off a strange odor

- ♦ If smells such as those of strong-smelling food or tobacco smoke are present in the room, they can enter the unit, leave trace deposits on the unit's internal components, and later be emitted from the unit.

## 14. Troubleshooting

### 14.1 General

- ♦ Sections 14.2 and 14.3 describe some initial troubleshooting steps that can be taken when an error occurs. If these steps do not resolve the issue, arrange for a professional technician to investigate the problem. Do not attempt further investigations or troubleshooting yourself.
- ♦ If any of the following errors occur, power the unit off, contact a professional technician immediately and do not attempt troubleshooting yourself:
  - a. A safety device such as a fuse or circuit breaker frequently blows/trips.
  - b. An object or water enters the unit.
  - c. Water is leaking from the unit.

 **Caution**

- Do not attempt to inspect or repair this unit by yourself. Arrange for a qualified technician to carry out all servicing and maintenance.

14.2 Unit Troubleshooting

Symptom	Possible causes	Troubleshooting steps
The unit does not start	A power cut has occurred (the power to the premises has been cut-off).	Wait for the power to come back on.
	The unit is powered off.	Power on the unit. This indoor unit forms part of an air conditioning system that has multiple indoor units that are all connected. The indoor units can not be powered on individually - they are all connected to one, single power switch. Ask a professional technician for advice regarding how to safely power on the units.
	The power switch fuse may have burned out.	Replace the fuse.
	The remote controller's batteries are dead.	Replace the batteries.
Air flows normally but doesn't cool	The temperature setting is not correct.	Set the desired temperature on the remote controller.
The unit starts or stops frequently	Arrange for a professional technician to check the following: <ul style="list-style-type: none"> <li>◆ Too much or too little refrigerant.</li> <li>◆ No gas in the refrigerant circuit.</li> <li>◆ The outdoor unit compressors have malfunctioned.</li> <li>◆ The power supply voltage is too high or too low.</li> <li>◆ There is a blockage in the piping system.</li> </ul>	
Low cooling effect	Doors or windows are open.	Close the doors and windows.
	Sunlight is shining directly onto the unit.	Close shutters/blinds to shield the unit from direct sunlight.
	The room contains many heat sources such as computers or refrigerators.	Turn off some of the computers during the hot test part of the day.
	The unit's air filter is dirty.	Clean the filter.
	The outside temperature is unusually high.	The cooling capacity of the system reduces as the outdoor temperature rises and the system may not provide sufficient cooling if the local climate conditions are not considered when the system's outdoor units were selected.
	Engage a professional air conditioning engineer to check the following: <ul style="list-style-type: none"> <li>◆ The unit's heat exchanger is dirty.</li> <li>◆ The unit's air inlet or outlet is blocked.</li> <li>◆ A refrigerant leak has occurred.</li> </ul>	
Low heating effect	Doors or windows are not completely closed.	Close doors and windows.
	Arrange for a professional technician to check the following: A refrigerant leak has occurred.	

### 14.3 Remote Controller Troubleshooting

Warning:

Certain troubleshooting steps that a professional technician may perform when investigating an error are described in this owner's manual for reference only. Do not attempt to undertake these steps yourself – arrange for a professional technician to investigate the problem.

If any of the following errors occur, power the unit off and contact a professional technician immediately. Do not attempt troubleshooting yourself:

- ◆ A safety device such as a fuse or circuit breaker frequently blows/trips.
- ◆ An object or water enters the unit.
- ◆ Water is leaking from the unit.

Symptom	Possible causes	Troubleshooting steps
The fan speed can not be adjusted	Check whether the MODE indicated on the display is "AUTO".	In automatic mode, the air conditioner will automatically change the fan's speed.
	Check whether the MODE indicated on the display is "DRY".	When dry mode is selected, the air conditioner automatically adjusts the fan speed. (The fan speed can be selected during "COOL", "FAN ONLY", and "HEAT".)
The remote controller signals not transmitted even when the ON/OFF button is pushed	A power cut has occurred (the power to the premises has been cut-off).	Wait for the power to come back on.
	The remote controller's batteries are dead.	Replace the batteries.
The indication on the display disappears after a certain time	Check whether the timer operation has come to an end when TIMER OFF is indicated on the display.	The air conditioner operation will stop up to the set time.
The TIMER ON indicator goes off after a certain time	Check whether the timer operation has come to an end when TIMER ON is indicated on the display.	Up to the set time, the air conditioner will automatically start and the appropriate indicator will go off.
No receiving sound from the indoor unit when the ON/OFF button is pressed	Check whether the signal transmitter of the remote controller is properly directed to the infrared signal receiver of the indoor unit when the ON/OFF button is pressed.	Directly transmit the signal transmitter of the remote controller to the infrared signal receiver of the indoor unit, and then press the ON/OFF button twice.



#### 14.4 Error Codes

With the exception of a mode conflict error, contact your supplier or service engineer if any of the error codes listed in the following table are displayed on the unit's display panel. If the mode conflict error is displayed and persists, contact your supplier or service engineer. These errors should only be investigated by a professional technician. The descriptions are provided in this manual for reference only.

Content	Display output	Possible causes
Mode conflict	E0	<ul style="list-style-type: none"> <li>♦ The indoor unit's operating mode conflicts with that of the outdoor units.</li> </ul>
Communication error between indoor and outdoor units	E1	<ul style="list-style-type: none"> <li>♦ Communication wires between indoor and outdoor units not connected properly.</li> <li>♦ Interference from high voltage wires or other sources of electromagnetic radiation.</li> <li>♦ Communication wire too long.</li> <li>♦ Damaged main PCB.</li> </ul>
Indoor ambient temperature sensor (T1) error	E2	<ul style="list-style-type: none"> <li>♦ Temperature sensor not connected properly or has malfunctioned.</li> <li>♦ Damaged main PCB.</li> </ul>
Indoor heat exchanger mid-point temperature sensor (T2) error	E3	
Indoor heat exchanger outlet temperature sensor (T2B) error	E4	
Fan error	E6	<ul style="list-style-type: none"> <li>♦ Fan stuck or blocked.</li> <li>♦ Fan motor not connected properly or has malfunctioned.</li> <li>♦ Power supply abnormal.</li> <li>♦ Damaged main PCB.</li> </ul>
EEPROM mismatch	E7	<ul style="list-style-type: none"> <li>♦ Damaged main PCB.</li> </ul>
EXV error	Eb	<ul style="list-style-type: none"> <li>♦ Line loosened or broken.</li> <li>♦ The electronic expansion valve is stuck.</li> <li>♦ Damaged main PCB.</li> </ul>
Outdoor unit error	Ed	<ul style="list-style-type: none"> <li>♦ Outdoor unit error.</li> </ul>
Water level error	EE	<ul style="list-style-type: none"> <li>♦ Water level float stuck.</li> <li>♦ Water level switch not connected properly.</li> <li>♦ Damaged main PCB.</li> <li>♦ Drain pump has malfunctioned.</li> </ul>
The indoor unit has not been assigned an address	FE	<ul style="list-style-type: none"> <li>♦ Indoor unit has not been assigned an address.</li> </ul>

#### Notes:

Flashing rapidly means flashing twice per second; flashing slowly means flashing once per second.

MD17I-017BW

16126000002930