

TCA 150D

part. no. 32186

Control module for temperature

Operating Instructions



Software version: D2033A from Version 1.00

Content

1	General notes	4
1.1	Structure of the operating instructions	4
1.2	Target group	4
1.3	Exclusion of liability	4
1.4	Copyright	4
2	Safety instructions	4
3	Product overview	5
3.1	Operational area	5
3.2	Function	5
3.3	Storage	5
3.4	Disposal / recycling	5
4	Mounting	6
4.1	General notes	6
4.2	Installation location for agriculture	6
4.3	Temperature influences during commissioning	6
5	Electrical installation	7
5.1	Safety precautions	7
5.2	EMC-compatible installation of control lines	7
5.3	Connection Voltage supply	7
5.4	Connection of sensor	7
5.5	Output voltage 0 - 10 V	8
5.6	Input for switch over Setpoint 1 / Setpoint 2	8
6	Device construction	8
7	Programming	9
7.1	Select operation mode	9
7.2	Menu structure	9
7.3	Menus of operating modes	10
7.4	Characteristic curve temperature sensor 2.00	12
7.5	Temperature controller 2.01	12
8	Start-up	13
8.1	Procedure	13

9	Enclosure	14
9.1	Technical data	14
9.2	Connection diagram	15
9.3	Dimensions [mm]	16
9.4	Manufacturer reference	17

1 General notes

1.1 Structure of the operating instructions

Before installation and start-up, read this manual carefully to ensure correct use!

We emphasize that these operating instructions apply to specific units only, and are in no way valid for the complete system!

Use these operating instructions to work safely with and on the device. They contain safety instructions that must be complied with as well as information that is required for failure-free operation of the device.

Keep these operating instructions together with the device. It must be ensured that all persons that are to work on the device can refer to the operating instructions at any time.

1.2 Target group

The operating instructions address persons entrusted with planning, installation, commissioning and maintenance and servicing and who have the corresponding qualifications and skills for their job.

1.3 Exclusion of liability

To allow for future developments, construction methods and technical data given are subject to alteration. We do not accept any liability for possible errors or omissions in the information contained in data, illustrations or drawings provided.

We accept no liability for damage caused by misuse, incorrect use, improper use or as a consequence of unauthorized repairs or modifications.

1.4 Copyright

These operating instructions contain copyright protected information. The operating instructions may be neither completely nor partially photocopied, reproduced, translated or put on data medium without previous explicit consent. Infringements are liable for damages. All rights reserved, including those that arise through patent issue or registration on a utility model.

2 Safety instructions

- Mounting, electrical connection, and start-up operation may only be carried out by an electrical specialist in accordance with electrotechnical regulations (e.g. DIN EN 50110 or DIN EN 60204)!
- Persons entrusted with the planning, installation, commissioning and maintenance and servicing in connection with the device must have the corresponding qualifications and skills for these jobs. In addition, they must be knowledgeable about the safety regulations, EU directives, rules for the prevention of accidents and the corresponding national as well as regional and in-house regulations.

- The equipment is to be used solely for the purposes specified and confirmed in the order. Other uses which do not coincide with, or which exceed those specified will be deemed unauthorised unless contractually agreed. Damages resulting from such unauthorised uses will not be the liability of the manufacturer. The user will assume sole liability.
- It is strictly forbidden for work to be carried out on any components while they are connected to live voltage.
- The safe isolation from the supply must be checked using a two-pole voltage detector.
- The owner is obliged to ensure that the device are operated in perfect working order only.
- Inspect electrical equipment periodically: retighten loose connections – immediately replace damaged lines and cables.
- Never clean electrical equipment with water or similar liquids.
- A separate fault and performance monitoring-system with an alarm signal function is necessary in order to prevent personal injuries and material damages during malfunctions and in case the device fails. Substitute operation must be taken into consideration!

3 Product overview

3.1 Operational area

Temperature control for e.g.: extraction systems, warm-air heaters, air curtain installations, liquid-cooling, chillers.

Controlled output (0 - 10 V) e.g. for activating a speed controller for fans.

Fans with integrated controller and input 0 - 10 V can be activated directly.

3.2 Function

The measured actual value at the sensor is compared with the adjusted target value.

Output voltage and thus fan speed is controlled automatically depending on the adjusted parameters.

Alternatively the device can be operated as temperature sensor. Output 0 - 10 V in this mode proportional to the adjusted measuring range (max. -50...150 °C).

3.3 Storage

- The device must be stored in its original packaging in a dry and weather-proof room.
- Avoid exposure to extreme heat and cold.
- Avoid over-long storage periods (we recommend a maximum of one year).

3.4 Disposal / recycling



Disposal must be carried out professionally and environmentally friendly in accordance with the legal stipulations.

4 Mounting

4.1 General notes

**Attention!**

The following points must be complied with during the mechanical installation to avoid causing a defect in the device due to assembly errors or environmental influences:

- Before installation remove the device from the packing and check for any possible shipping damage!
- Assemble the device on a clean and stable base. Do not distort during assembly! Use the appropriate mounting devices for proper installation of the unit!
- Do not mount equipment on vibrating base!
- When mounted onto lightweight walls, there must be no impermissibly high vibrations or shock loads. Any banging shut of doors that are integrated into these lightweight walls, can result in extremely high shock loads. Therefore, we advise you to decouple the devices from the wall.
- Do not allow drilling chips, screws and other foreign bodies to reach the device interior!
- The device should be installed in a location where it will not be disturbed, but at the same time can be easily accessed!
- Any cable ducts openings not used must be sealed!
- Care must be taken to avoid direct radiation from the sun!
- The device is designed for vertical installation (cable inlet down). A horizontal or reclined installation is only permissible after technical release of the manufacturer!

4.2 Installation location for agriculture

In order to avoid damage caused by ammoniac vapours, the controller shall not be installed in the stable, but rather in an outhouse wherever possible.

4.3 Temperature influences during commissioning

Avoid condensation in the controller and functional faults attributable to condensation by storing the controller at room temperature!

5 Electrical installation

5.1 Safety precautions



Danger due to electric current

- Work on electric components may only be carried out by trained electricians or by persons instructed in electricity under the supervision of an electrician in accordance with electrical engineering regulations.
- The programming of the equipment takes place with switched on supply voltage by opened cover and voltage for change-over Setpoint 1/2. Use power supplies which guarantee reliable electrical isolation of the operating voltage as per IEC/-DIN EN 60204-1. Consider also the general requirements for PELV circuits in accordance with IEC/DIN EN 60204-1.
- Inspect electrical equipment periodically: retighten loose connections – immediately replace damaged lines and cables.
- Never clean electrical equipment with water or similar liquids.



Information

The respective connections are represented in the enclosure of this manual (☞ Connection diagram)!

5.2 EMC-compatible installation of control lines

Pay attention to maintain sufficient distance from powerlines and motor wires to prevent interferences. The control cable may not be longer than 30 m. Screened control cables must be used when the cable length is longer than 20 m!

5.3 Connection Voltage supply

Connection Voltage supply at terminals: “+Ub” and “GND”. Here, it must be strictly observed that the mains voltage lies within the allowable tolerance specifications (☞ Technical data and nameplate affixed to the side).

5.4 Connection of sensor

Connection of temperature sensor for measuring actual value (not in scope of delivery) to terminals “TF”. It is possible to connect sensors of series “TF..” (KTY81-210) or PT1000 temperature sensors. It must be paid attention to no polarity.

For a high interference immunity a capacitor must be connected directly to the sensor (1 nF parallel). With temperature sensors type TF.. (KTY81-210) a capacitor is integrated.



Attention!

Never apply line voltage to analog inputs!

5.5 Output voltage 0 - 10 V

Connection to Terminals "A" - "GND" (I_{max} Technical data).

It is not permissible to connect outputs of several devices to each other!

5.6 Input for switch over Setpoint 1 / Setpoint 2

Via voltage at terminals "1" and "2" (10... 24 V DC) a switchover between Setpoint 1 and Setpoint 2 is possible (note polarity connection diagram).

20.0 °C
Setpoint 1

None Voltage at terminals "1" and "2" = adjustment for Setpoint1 active.

15.0 °C
Setpoint 2

Voltage at terminals "1" and "2" = adjustment for Setpoint 2 active.

The active Setpoint is indicated in the menu INFO, an active "Setpoint 2" is signaled by the moon symbol.

6 Device construction

Screw off the hinged cover to proceed with electrical connection and programming. Subsequently close carefully!

	D	LC-Display Moon symbol = Adjustment for Setpoint 2 active != Exceeding measuring range (sensor interruption / sensor short-circuit)
	+Ub / GND	Voltage supply
	A / GND	Output signal 0 - 10 V
	TF / TF	Connection temperature sensor (KTY81-210 or PT1000)
	1 / 2	Voltage input for switch over Setpoint 1 / Setpoint 2

Multipurpose LC display and internal keyboard

27.5 °C
Actual Value

P ▼ ▲

Text line 1 with 16 figures for display of actual and desired values
 Text line 2 with 16 figures for display of menu text

- P** Program key and open menu
- ▼** Menu selection, reduce value
- ▲** Menu selection, increase value
- ▼ + ▲** ESC-key combination, Escape = leave menu

7 Programming

7.1 Select operation mode



Information

Simple installation is possible through the selection of the preprogrammed mode of operation.

This determines the basic function of the device, factory set **2.01**.

Mode	Function
2.00	Temperature sensor: output 0...10 V proportional to measuring range
2.01	Temperature controller (P): output 0...10 V depending on adjusted Setpoint an measured actual value (Factory setting)

7.2 Menu structure

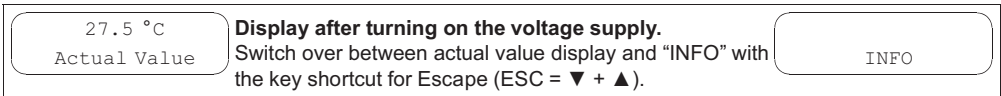

Example for Mode **2.01** (Factory setting)

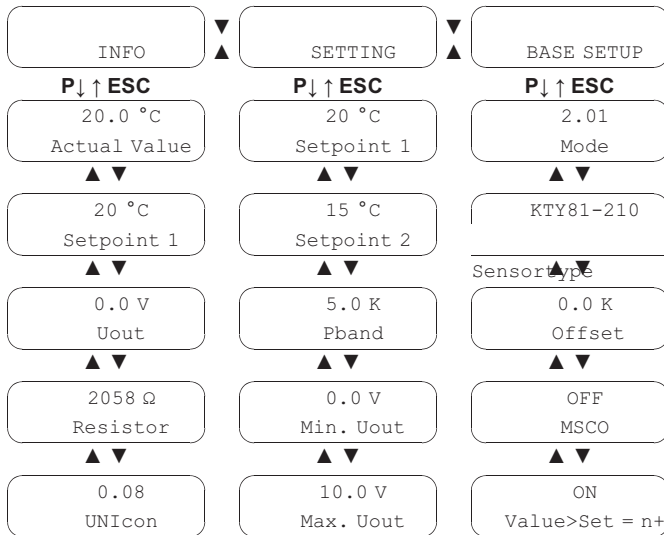

Selection of the menu group (e.g. BASE SETUP) to the right through the ▼-key, to the left through the ▲-key.

You can go to the menu items in the menu groups (e.g. mode) by using the **P** key. Use the arrow keys to move up and down within the menu group.
 To make adjustments, press the **P** key after selecting the menu item. If the previously set value starts to flash, it can be adjusted with the **▼ + ▲** keys and then saved with the **P** key. To exit the menu without making any changes, use the “Esc” short-key, i.e., the originally set values remain.

Reprogramming Mode **2.01** to **2.00** in “BASE SETUP”



7.3 Menues of operating modes

Parameter	Factory setting		User Setting	Function
Mode	2.00	2.01		Mode
INFO				
Actual Value	27.1 °C	27.1 °C		Display actual temperature
Setpoint 1	-	20.0 °C		Display active Setpoint
Uout	5.0 V	5.0 V		Magnitude of the output voltage 0...10 V
Resistor	2049 Ω	2049 Ω		current resistance value of the temperature sensor
UNIcon	1.00	1.00		software version
SETTING				
Setpoint 1	-	20.0 °C		Setpoint1 Setting range: -50.0...+150.0 °C Factory setting: 20.0 °C
Setpoint 2	-	15.0 °C		Setpoint 2 active, if voltage at terminals 1, 2 Setting range: -50.0...+150.0 °C Factory setting: 15.0 °C
Pband	-	5.0 K		Pband Setting range: 1.0...50.0 K Factory setting: 5.0 K
Min. Uout	0.0 V	0.0 V		Setting minimal output voltage
Max. Uout	10.0 V	10.0 V		Setting maximal output voltage

Parameter	Factory setting		User Setting	Function
BASE SETUP				
Mode	2.00	2.01		Mode selection
Sensortype	KTY81-210	KTY81-210		Setting type of sensor: KTY81-210 or PT1000
Range min. Temperature	-50 °C	-		Setting measuring range, minimum temperature value Setting range: -50...150 °C Factory setting: -50 °C
Range max. Temperature	150 °C	-		Setting measuring range, maximum temperature value Setting range: 150...-50 °C Factory setting: 150 °C
Offset	0.0 K	0.0 K		Sensor offset
MSCO	-	OFF		<p>Minimum speed cut off <input type="checkbox"/> MSCO: <input type="checkbox"/> OFF (factory setting) If "Min. Uout" is adjusted (e.g. 2.0 V), than no disconnection of the output takes place (does not go under "Min. Uout"). <input type="checkbox"/> MSCO: <input type="checkbox"/> -2.0 K (example) It takes place a disconnection from Setting "Min. Uout" to "0", if the given difference is reached related to the Setpoint. At a plus value (+) before reaching the desired value At a minus value (-) after falling below the desired value. Hysteresis <input type="checkbox"/> H ON /OFFs: approx. 1 K Setting range: -10.0 K...+10.0 K</p>
Value>Set = n+	-	ON		<p>Controller function <input type="checkbox"/> Value>Set = n+: <input type="checkbox"/> ON Cooling = increasing modulation for increasing actual value over Setpoint. <input type="checkbox"/> Value>Set = n+: <input type="checkbox"/> OFF Heating = increasing modulation for decreasing actual value below Setpoint.</p>

- Parameter for selected mode not available

7.4 Characteristic curve temperature sensor **2.00**

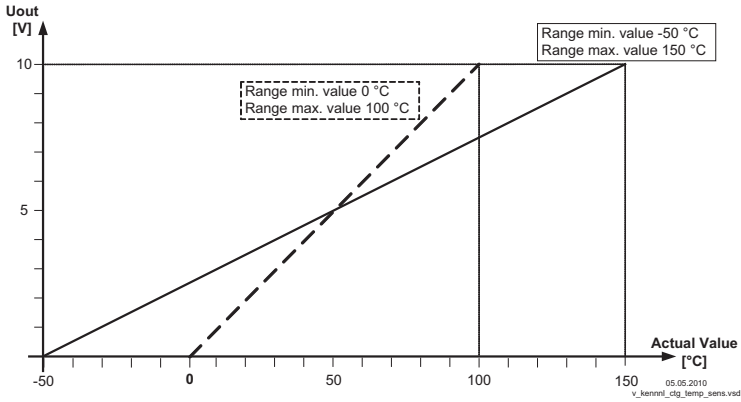

7.5 Temperature controller **2.01**

Functional diagrams temperature control

Cooling: : ON

Heating: : OFF

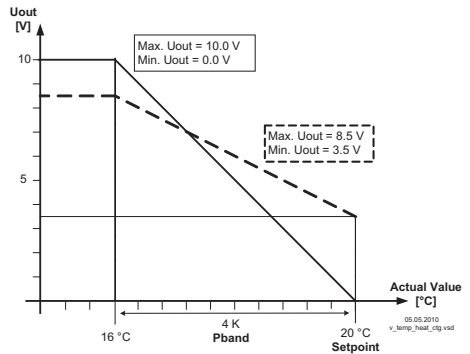
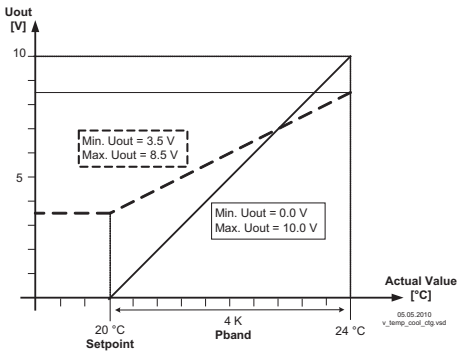

Minimum speed cut off

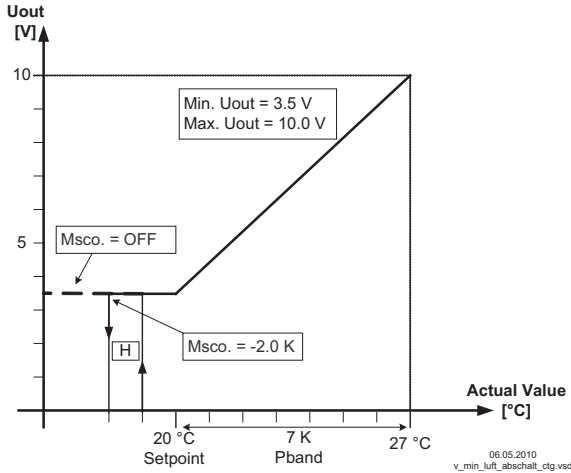

8 Start-up

8.1 Procedure

1. You must mount and connect the device in accordance with the operating instructions.
2. Double check that all connections are correct.
3. The supply voltage must match the information on the rating plate.
4. Set the operating Mode in the **BASE SETUP** (factory settings **2.01**).
5. When saving the Operating Mode, the factory settings are stored.
Therefore the settings you have made, e.g. in "SETTING" are lost.

Attention, electrostatic sensitive devices!

Be sure to ground the board at a suitable point in order to prevent damage to the electronic components being caused by electrostatic discharges. Such damage could occur, e.g., if a metal water pipe or heating line are briefly touched.



9 Enclosure

9.1 Technical data

Type	TCA 150 D
Part-No.	32168 (320048-42)
Measuring range	-50...150 °C (external sensor KTY81-210 or PT1000)
Voltage supply U_B	10 V...24 V DC Protected against reverse polarity

	@ U_B 10 V DC	@ U_B 13...24 V DC
Max. load output 0 - 10 V (short-circuit-proof)	0,3 mA	10 mA
Max. current consumption ca.	6 mA	14 mA

LC-Display	double-row (max. 16 digits each)
Housing	Cover ABS, bottom Polyamid PA 6.6 Fire protection classification UL 94 HB
Protection class	IP54 according EN 60529
Weight	approx. 200 g
Permissible ambient temperature	-10 °C...50 °C
Permissible rel. humidity	85 % no condensation
Interference emission	according EN 61000-6-3 (domestic household applications)
Interference immunity	according 61000-6-2 (industrial applications)

9.2 Connection diagram

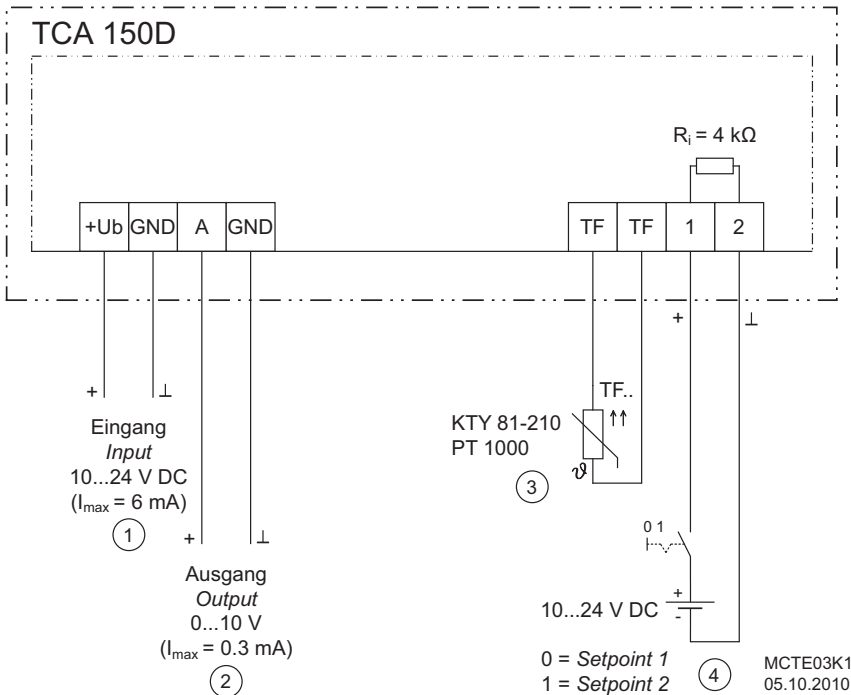

- 1 Voltage supply 10...24 V DC
- 2 Output 0...10 V
- 3 Temperature sensor KTY 81-210 or PT 1000
- 4 Voltage input for switch over Setpoint 1 / Setpoint 2

9.3 Dimensions [mm]

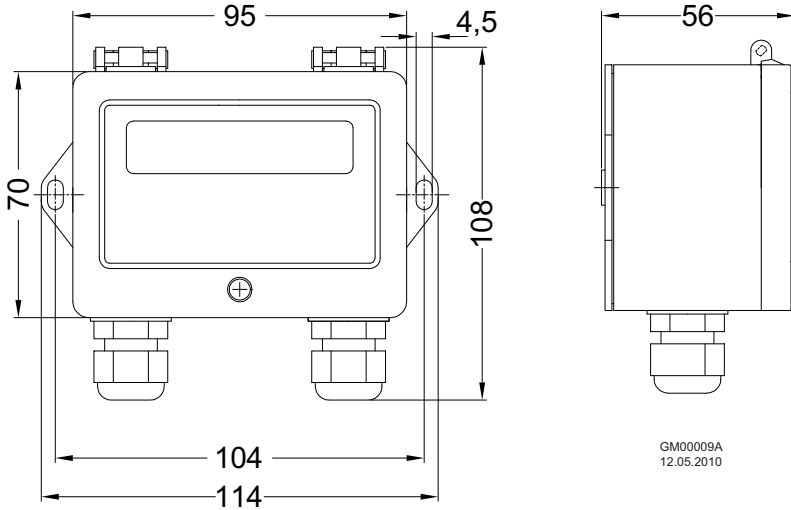

9.4 Manufacturer reference

Our products are manufactured in accordance with the relevant international regulations. If you have any questions concerning the use of our products or plan special uses, please contact:

Systemair
Industrievägen 3
73930 Skinnskatteberg
Telefon:+46 (0) 222 440 00
Telefax:+46 (0) 222 440 99
mailbox@systemair.se
www.systemair.se