

FCC – free cooling control

Item no. 238089

FEATURES

- Measuring the room and outdoor air temperature
- Start of fans if the cooling conditions reached. (temperature difference)
- Temperature difference and min. room temperature adjustable
- Activation of the ventilation via relays contact
- Activation of DC- or AC-fans and ventilation systems
- Activation of actuators for windows or ventilation dampers



Image 1 free cooling control

APPLICATION

- Cool outdoor air reduce the room temperature by temperature comparison.
- Temperature adjustment by starting of extract or supply air fans as well as central or decentral ventilation systems
- Temperature adjustment by starting of window or ventilation damper actuators

DESCRIPTION

The controller uses the internal sensor to measure the room air temperature. The temperature of the outdoor air measured with the outdoor air sensor. The adjustable temperature difference (temperature of the outdoor air lower than the temperature of the room air), the relay is active and the fan begins to ventilate. If the temperature difference becomes lower than the set value, the ventilation switch off. The temperature difference is adjustable with switch S2. As a second condition, the minimum room air temperature can be set with switch S1. The ventilation switched off or don't start at temperature below.

The button T1 do a functional test of the ventilation. When the button is pressed, the relay closes and the fan begins to start.

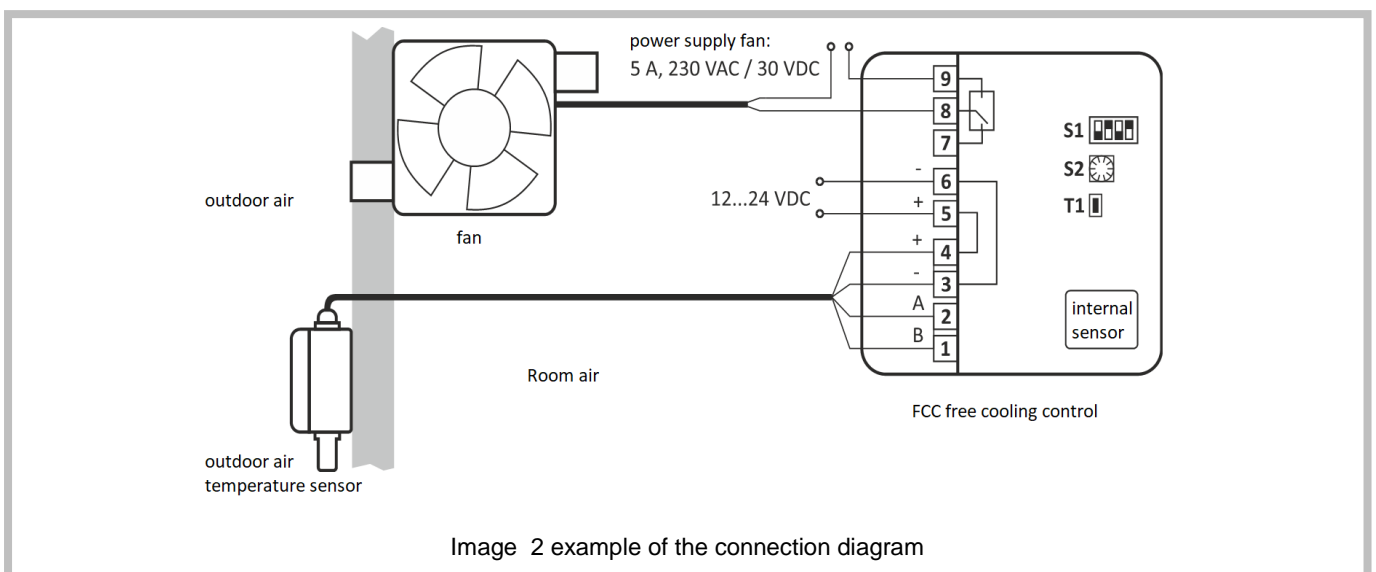

Image 2 example of the connection diagram





ATTENTION

Connect only low voltage to the terminals 1...6. If 230V is connected to terminal 7...9 following is to consider:

- The enclosed protective cover must be installed!
- Fix the power cable with the attached cable tie at the fixing loop.



TERMINALS

The following table describes the connection terminals of the device and their function. The connection numbers are on the terminals in the device. Details of the connections described in the technical data.

Connection	Name	Description	
01	B	Communication outdoor sensor	
02	A	Communication outdoor sensor	
03	-	reference outdoor sensor	
04	+	supply voltage output for the outdoor sensor	
05	+	supply voltage output for the control	
06	-	Reference supply voltage	
07	NC	Relay for activation of the fan	 Fan switched OFF  Fan switched ON
08	COM		
09	NO		



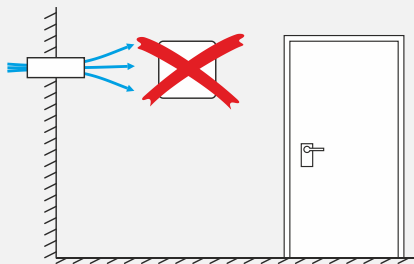
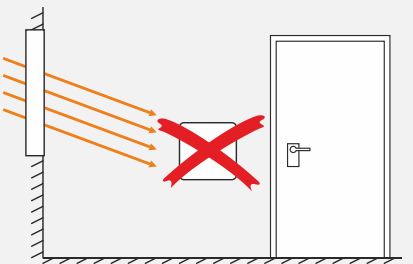
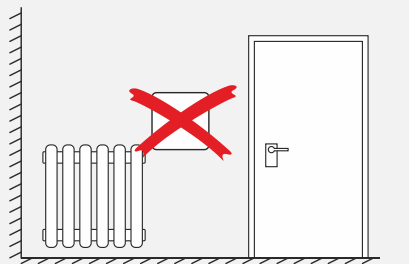
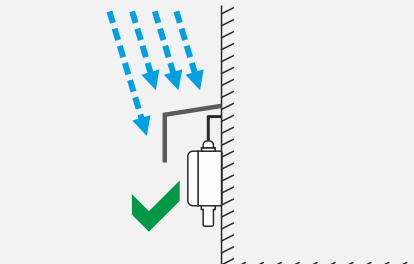
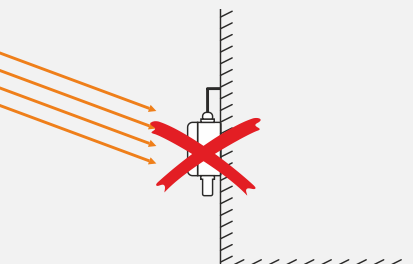

INSTALLATION INSTRUCTION

The following instruction must be observed when installing the system. If the instruction not followed, the function of the control and the sensors may be impaired. The tolerances and properties described in the technical data no longer observed.



<p>Do not install the control direct at the supply air.</p> 	<p>Do not install the control at direct sunlight.</p> 	<p>Do not install the control close to heating sources.</p> 
<p>Protect the outdoor sensor from rain.</p> 	<p>Do not install the outdoor sensor at direct sunlight.</p> 	<p>Preferable installation of the outdoor sensor at the north side.</p> 

OPERATION MODE AND SIGNAL OF THE LED

The LED shows operation mode of the control as well as errors in colour and by flashing. (The display has a short delay after switching on the control.)

LED	Display	Operation	Ventilation	Description	
	Green	Permanent	Possible	ON	ventilation condition fulfilled
	Blue	Permanent	Not possible	OFF	room air too cold
	Yellow	Permanent	Not possible	OFF	outside air too warm
	Green	Flashing	-	ON	function test with button

Beide LED zeigen vorliegende Fehler der Sensoren als Status wie folgt an:

LED	Display	Error	Function	Description	
	Rot	Flashing	Control	OFF	Control or internal sensor without function
	blue	Flashing	Outdoor sensor	OFF	Outdoor sensor not correct connected or without function

(If both colours are changing, both errors are active.)

BUTTON FOR FUNCTION TEST



A functional test of the ventilation carried out with the micro button T1. When the button is pressed, the relay is closed and the fan active. The function test end by releasing the button. If the button pressed for longer than 1 min, the control automatically switches off the function test. The signal LED also shows the function test.

SETTING THE TEMPERATURE DIFFERENCE

Switch S2 set the temperature difference, which the ventilation switched ON and OFF. The temperature difference is the difference between the temperature of the room air and the temperature of the outdoor air (temperature difference = temperature room air - temperature outdoor air).















The ventilation condition fulfilled and the ventilation is active when the outside air is cooler than the room air (or at least as cold) by the set difference and the hysteresis. (Value of the hysteresis, see technical data)

The ventilation only start if the minimum room temperature condition is complied.

Switch S2 – setting the temperature difference					
	Temperature difference			Temperature difference	
0	0 K		5	5 K	
1	1 K		6	6 K	
2	2 K		7	7 K	
3	3 K		8	8 K	
4	4 K (factory settings)		9	9 K	

SETTING THE MINIMUM ROOM TEMPERATURE



The switch S1 sets the minimum temperature of the room air. If the room temperature falls below the set value, the ventilation switched off or not switched on. If the temperature falls below the minimum room temperature, the ventilation only switched on again, when the measured temperature is higher than the set value and additional the value of the hysteresis. (Value of the hysteresis, see technical data)

Switch S1 – Setting the minimum room temperature					
DIP	S1.1	S1.2	S1.3	S1.4	Minimum room temperature
	OFF	OFF	OFF	OFF	10 °C
	OFF	OFF	OFF	ON	11 °C
	OFF	OFF	ON	OFF	12 °C
	OFF	OFF	ON	ON	13 °C
	OFF	ON	OFF	OFF	14 °C
	OFF	ON	OFF	ON	15 °C
	OFF	ON	ON	OFF	16 °C
	OFF	ON	ON	ON	17 °C
	ON	OFF	OFF	OFF	18 °C
	ON	OFF	OFF	ON	19 °C
	ON	OFF	ON	OFF	20 °C
	ON	OFF	ON	ON	21 °C
	ON	ON	OFF	OFF	22 °C (factory setting)
	ON	ON	OFF	ON	23 °C
	ON	ON	ON	OFF	24 °C
	ON	ON	ON	ON	25 °C

TECHNICAL DATA

Main power supply		
Supply voltage	12 ... 24 VDC $\pm 10\%$	
Supply power	1 W (without outdoor sensor)	
Relay NC, COM, NO		
Switching capacity	230 VAC, 5 A, $\cos\phi = 1$ 30 VDC, 5 A 48 VDC, 1,5 A	
Isolation	4 kV (against all other connection)	
Connection outdoor sensor A, B		
Type	RS-485	
Baudrate	9600 baud	
Temp.-Sensor	Measuring range	Tolerance
Temperature	-30 ... +90 °C	$\pm 0,5$ K (0 ... +60 °C)
Dew point temperature	-70 ... +90 °C	$\pm 1,5$ K
Hysteresis		
Temperature difference	0,5 K	
min. room temperature	0,5 K	
Mechanical data		
Dimensions (L x W x H)	88 x 88 x 31 mm	
Weight	100 g	
Protection	IP20	
Protection class	II	
Degree of pollution	2	
Mounting	Wall mounting, surface	
Connection		
Type of connection	Screw clamp	
Terminal	Terminal 1 ... 6:	
	rigid	0,14 ... 1,5 mm ²
	flexibel	0,14 ... 1,0 mm ²
	end splice	0,25 ... 0,5 mm ²
Terminal	Terminal 7 ... 9:	
	rigid	0,14 ... 2,5 mm ²
	flexibel	0,14 ... 1,5 mm ²
	end splice	0,25 ... 1,5 mm ²
Length	Terminal 1 ... 6: max. 30 m	Terminal 7 ... 9: unlimited
Environmental conditions		
Operating temperature	-20 ... 50 °C	
Storage temperature	-20 ... 80 °C	
Humidity	0 ... 95 % no condensation	

GUIDELINES / STANDARDS

Guideline	Standard
Low voltage directive 2014/35 / EU	EN 60730-1, Automatic electrical controls - General requirements EN 60730-2-9, Automatic electrical controls - Part 2-9: Particular requirements for temperature sensing control EN 60730-2-13, Automatic electrical controls - Part 2-13: Particular requirements for humidity sensing controls EN 62368-1, Audio/video, information and communication technology equipment - Part 1: Safety requirements
EMC directive 2014/30 / EU	EN 55011, Industrial, scientific and medical equipment - Radio-frequency disturbance characteristics - Limits and methods of measurement EN 61000-6-2, Electromagnetic compatibility (EMC) - Part 6-2: Generic standards - Immunity standard for industrial environments EN 61000-6-3, Electromagnetic compatibility (EMC) - Part 6-3: Generic standards - Emission standard for residential, commercial and light-industrial environments
RoHS directive 2011/65 / EU	
Identification / marking	
	

DRAWING

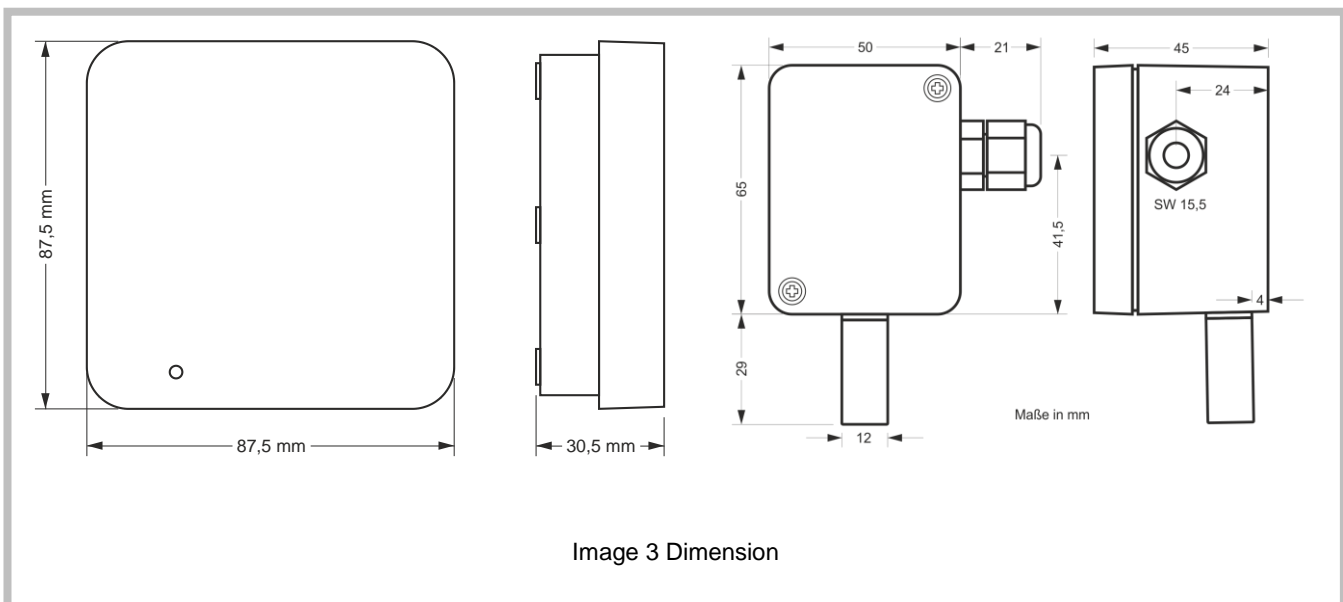

Systemair GmbH

Seehöfer Straße 45, 97944 Boxberg
Tel.: +49 7930 92 72-0, Fax.: +49 7930 92 72-92
info@systemair.de www.systemair.de

V.06/2020 MISC